



nepal

Visit Nepal Year 2020 and beyond

Branding Guidelines

July 2019



Visit Nepal Year 2020 and beyond

Branding Guidelines

This document is a set of corporate design standards that ensure that Visit Nepal 2020 projects a professional and consistent image. It gives the campaign a distinctive visual profile and captures the various elements of its external presentation. Everyone at Visit Nepal 2020 is responsible for safeguarding the integrity of its visual identity. Therefore everyone should be acquainted with the content of this document and apply the guidelines in their own work.

July 2019

Contents

- | | | |
|---|--|--|
| 1 Logo <small>4</small> | 7 Copywriting <small>30</small> | 13 Exhibitions <small>68</small> |
| 2 Main Graphics <small>10</small> | 8 Patterns <small>32</small> | 14 Environmental Design <small>74</small> |
| 3 Tagline <small>16</small> | 9 Supergraphics <small>36</small> | 15 Online Applications <small>82</small> |
| 4 Colour Palette <small>20</small> | 10 Stationery <small>42</small> | 16 Social Media <small>88</small> |
| 5 Typeface <small>22</small> | 11 Print Media <small>50</small> | 17 Transports <small>92</small> |
| 6 Photography <small>24</small> | 12 Packaging <small>62</small> | 18 Uniforms <small>98</small> |



Lifetime
Experiences!



- 1.1 Clear Space
- 1.2 Minimum Logo Size
- 1.3 Logo on Different Backgrounds
- 1.4 Logo Don'ts

1.1 Clear Space



1.2 Minimum Logo Size



The logo clear space is proportionally equivalent to the width of its N in any ratio.

The minimum height of the VNY logo is 1.5cm(0.590in) .

When the logo is placed on a background, care should be taken that the colours and content of the background do not obscure the logo or interfere in any way with the reading of the logo.

For this, the logo should create a clear contrast, and the context of the background must clearly relate to the work of VNY.

1.3 Logo on Different Backgrounds

This



Not this



Use a colour that matches the logo colour.

Backgrounds containing information on the photo (such as watermark or photography credit) or another brand should be avoided.

Only the very best images should be used as background to the VNY logo.
Try to keep a clean and distinct identity.

1.4 Logo Don'ts

Resist these temptations:

Distorting the logo by scaling it manually or placing it on a path.



Using the logo outside the VNY colour palette. See section on colour.



Typing the logo or tagline.

Visit Nepal

Using a Photoshop effect such as drop shadow, emboss or glow.





2

Main Graphics

- 2.1 Clear Space
- 2.2 Minimum Main Graphics Size
- 2.3 Main Graphics on Different Backgrounds
- 2.4 Main Graphics Don'ts

2.1 Clear Space



2.2 Minimum Main Graphic Size



The main graphics clear space is proportionally equivalent to the width of its n in any ratio.

The minimum height of the main graphics is 1.5cm (0.590in).

When the main graphic is placed on a background, care should be taken that the colours and content of the background do not obscure the main graphics or interfere in any way with the reading of the main graphic.

2.3 Main Graphic on Different Backgrounds

This



Not this



Backgrounds containing information on the photo (such as watermark or photography credit) or another brand should be avoided.

Only the very best images should be used as background to the VNY logo. Try to keep a clean and distinct identity.

2.4 Main Graphic Don'ts

Resist these temptations:

Distorting the main graphics by scaling it manually or placing it on a

~~nepal~~

Using the main graphics outside the colour palette. See section on colour.

~~nepal~~

Typing the main graphics or tagline.

~~nepal~~

Using a Photoshop effect such as drop shadow, emboss or glow.

~~nepal~~

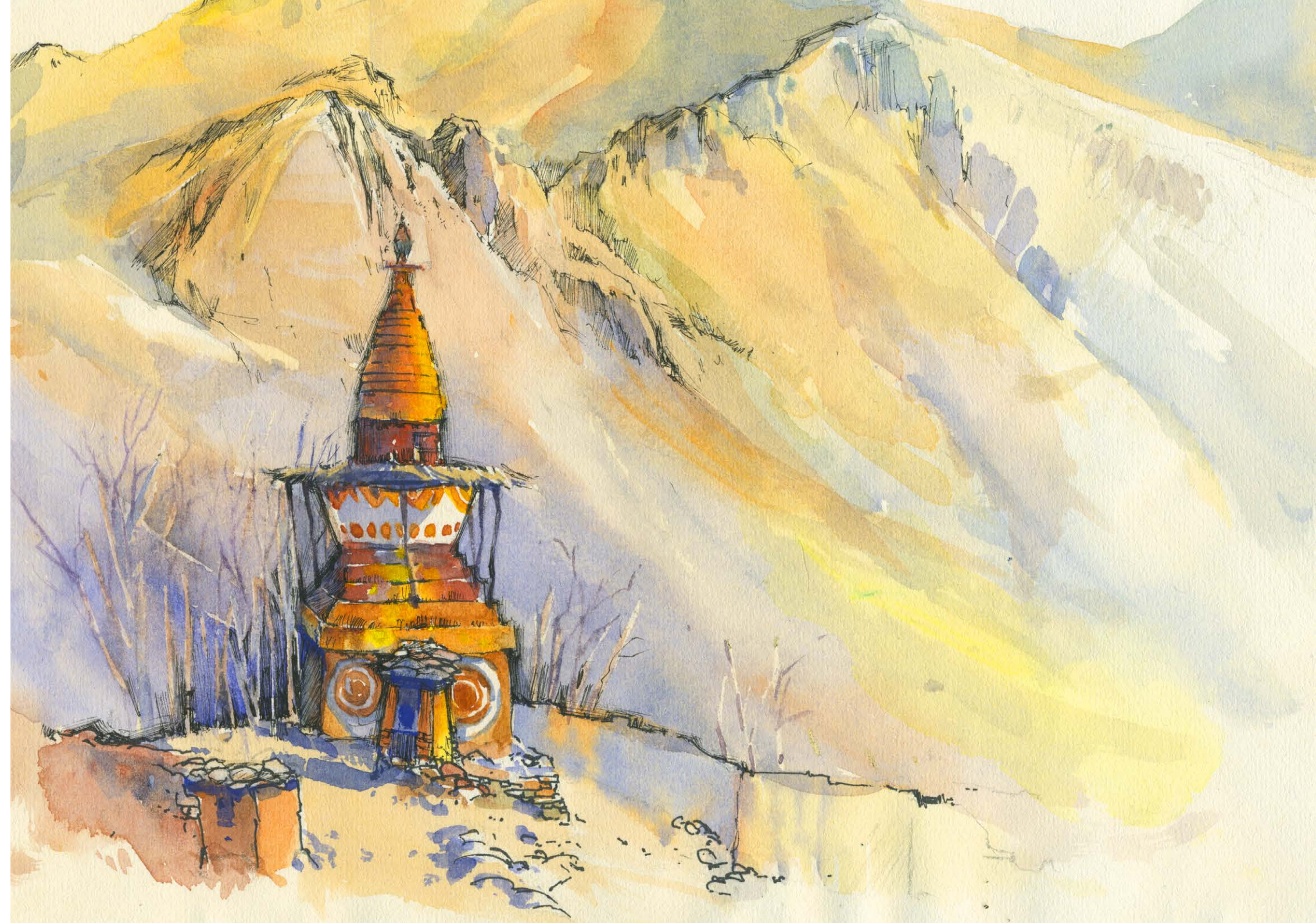



Tagline
3

*Lifetime
Experiences!*

3.1 Tagline

'Lifetime Experiences!' is the tagline of the campaign. The tagline should always be used in given formats. It should not be retyped in any case unless when use in documents as a text format.

Lifetime Experiences!

Lifetime Experiences!

Lifetime Experiences!

Email

Dear Bob,
I am enjoying my time in Nepal.
The tourism campaign is really amazing. We are having real 'Lifetime Experiences!'.
I wish you were here.
All the best,
Anna

When using the tagline in text formats (email, letters) always use the exclamation mark.





Colour Palette

4

Our core colors are Marigold, Bluish Grey, Red and white.

The right value of these colors should be maintained in all collaterals, stationery, publications and online materials.

4.1 Primary Colours



Marigold

C 3%
M 17%
Y 97%
K 0%



Bluish Grey

C 76%
M 58%
Y 49%
K 30%



Red

C 18%
M 99%
Y 94%
K 8%



White

C 0%
M 0%
Y 0%
K 0%

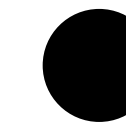

Black

C 100%
M 100%
Y 100%
K 100%

4.2 Secondary Colours



Turquoise

C 90%
M 54%
Y 43%
K 21%



Teal Green

C 99%
M 31%
Y 72%
K 19%



Burnt Amber

C 58%
M 52%
Y 62%
K 29%



Hot Pink

C 12%
M 84%
Y 19%
K 0%



Gold

C 27%
M 24%
Y 100%
K 0%

These secondary colors are used as supporting colors for illustrations, products, packagings and web platform.



5 Typeface

Typography is an important element of our brand. By controlling the type styles and alignment used, we further strengthen the visual distinctiveness of VNY.

Our typefaces are Quicksands and Univers LT. These fonts are clear and legible.

Typeface harmony should be maintained by using these two font families.

Sample text

What is Lorem Ipsum?
Lorem Ipsum is simply dummy text of the printing and typesetting industry. Lorem Ipsum has been the industry's standard dummy text ever since the 1500s, when an unknown printer took a galley of type and scrambled it to make a type specimen book.

5.1 Use of the VNY Typefaces

Quicksands Light
Quicksands Regular
Quicksands Medium
Quicksands Bold

Quicksands is used in document titles, headlines or in very short sentences or paragraphs for strong emphasis where the font makes the communication stand out. It should never be used for body text or in letters.

Univers LT Std
Univers LT Std Oblique
Univers LT Roman
Univers LT Oblique
Univers LT Bold
Univers LT Bold Oblique
Univers LT Black
Univers LT Black Oblique

Univers LT is a comfortably legible font that may be used in body text and communications, according to individual preferences.

K chha?

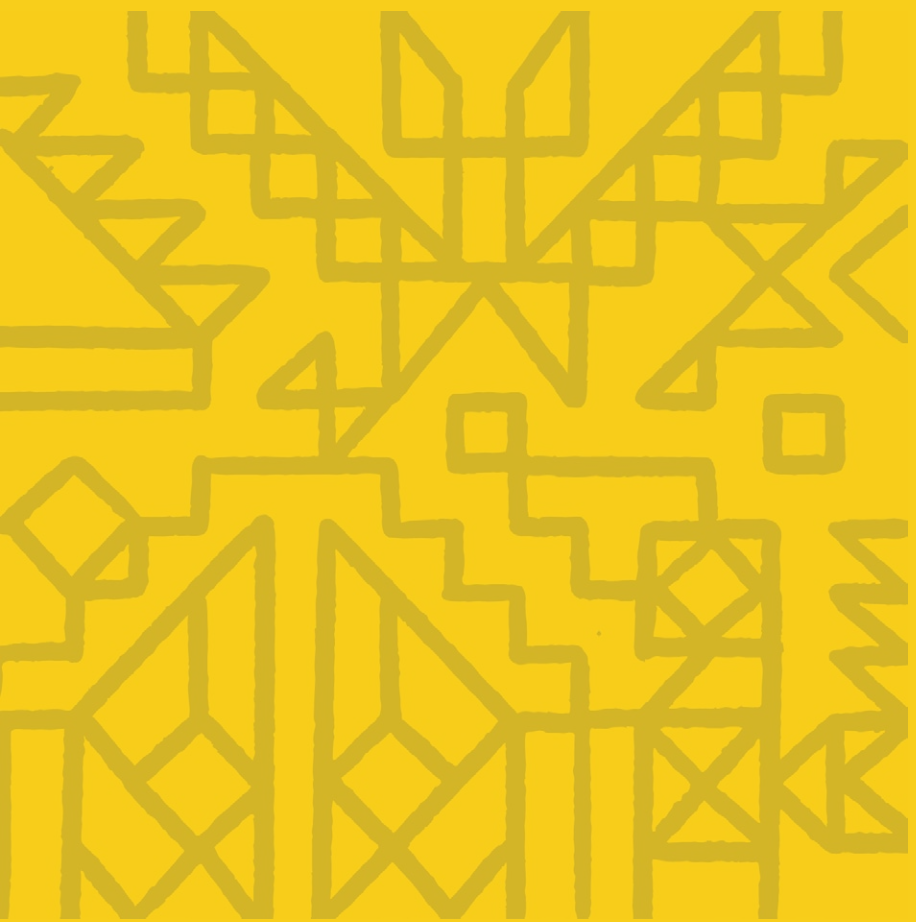

6

Photography

6.1 For Photographers

Photographs are meant to reflect the tagline of the campaign: Lifetime Experiences!. As such, while respecting individual creativity, the images should portray positive aspects of Nepal. As much as possible the tone should be energetic for adventure photos, artistic for spiritual photos and inspiring for people portraits. Aspects of poverty are discouraged. Great care should be taken when portraying children.

Only use original high resolution professional photography. Minimum 30 mega pixels.

Identifiable people featured in the image must have given the consent.

All the photographs must be from Nepal unless it is a specific communication from abroad but related to Nepal.

Photography of strategic areas airport, bridges, military infrastructure are forbidden.

Photographs must be respectful of cultural norms.

No mobile photography except for social media.

Credit the photographer as shown.

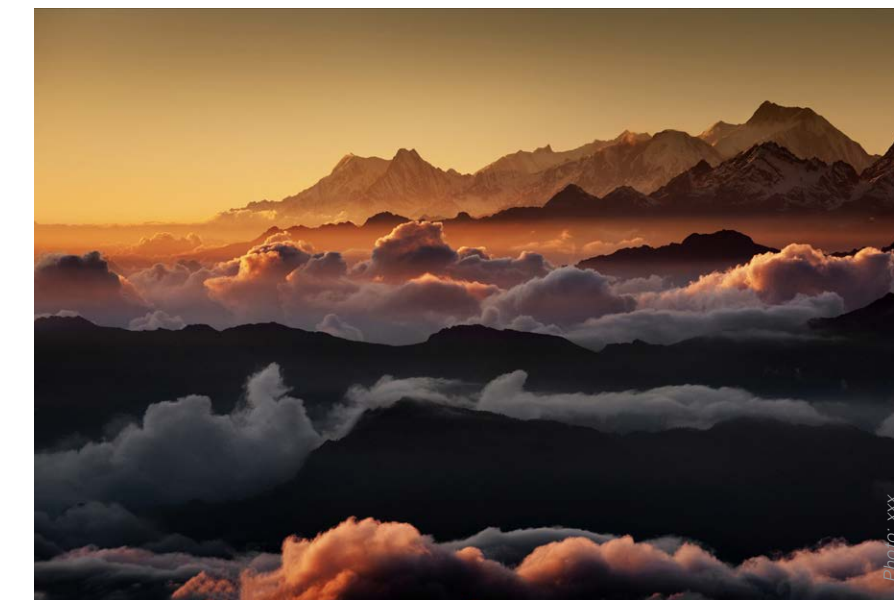

Photographer's credit

6.2 For Professional Photo Editors

The ratio of photographs must be respected, not stretched or forced to fit in a frame. Editing should be done by **professionals**. No photo manipulation, no special effects.

The visual integrity of the photo must be preserved. Avoid placing text on the photo.

No mobile photography except for social media.

Credit the photographer.

The captions must correspond to the photographs.

Editing has to be done only by **professional** editors using **professional** photo editing softwares such as Photoshop and Lightroom.

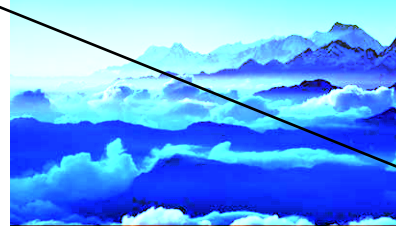

6.3 Adventure



6.4 Culture



6.5 Spirituality





7

Copywriting

Elegant

We keep it classy and well-mannered. We communicate with a storytelling language to invoke a sense of wonder.

Friendly

We capture people's hearts by keeping it fun and loving. We communicate in the most honest way.

Modern and Inquisitive

We use modern language to approach our target audience and we encourage people to tell us their story.



8

Patterns

Our handdrawn patterns are key graphic elements. Each pattern carries stories of Nepal.

These patterns are used partially in print applications and fully in merchandising.



8.1 Adventure

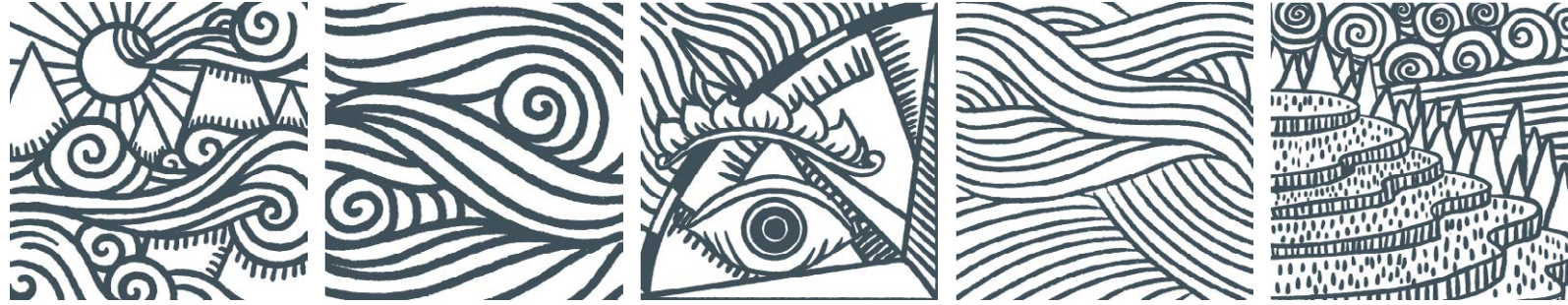

8.3 Spirituality



8.2 Culture

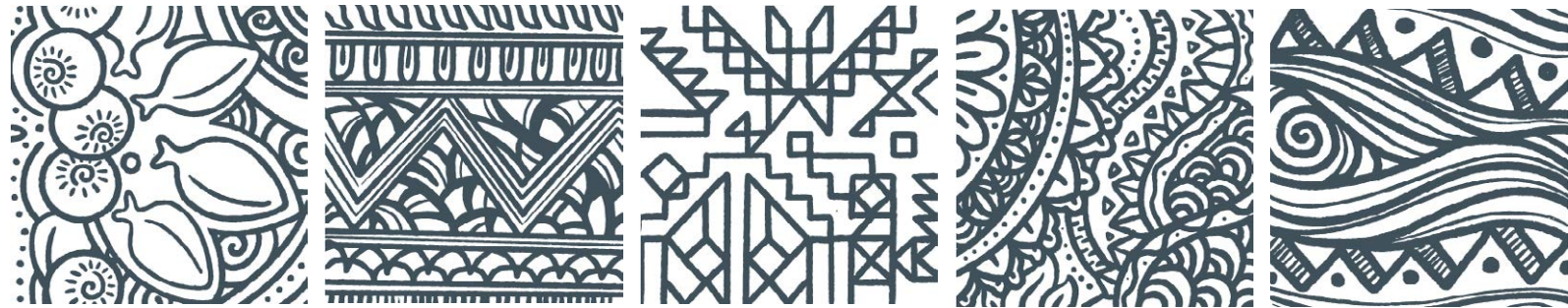

8.4 Special

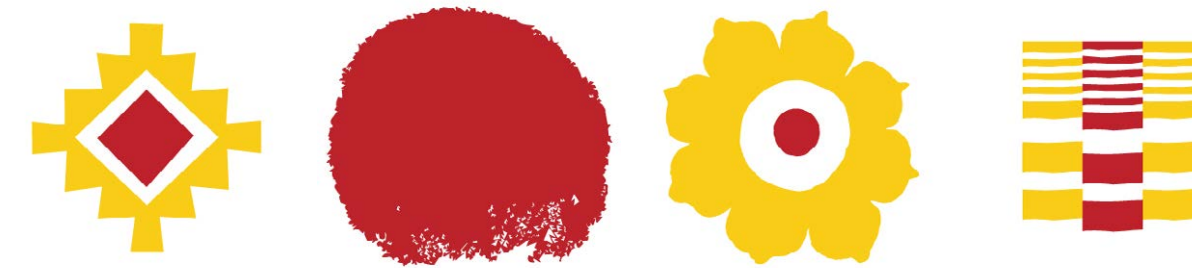



9

Supergraphics

The supergraphic is an outline of the Himalayan Range drawn from the southern view of the range. This design element is visually very present.

It helps to separate our media into two different types of communication when accompanied by a pattern.

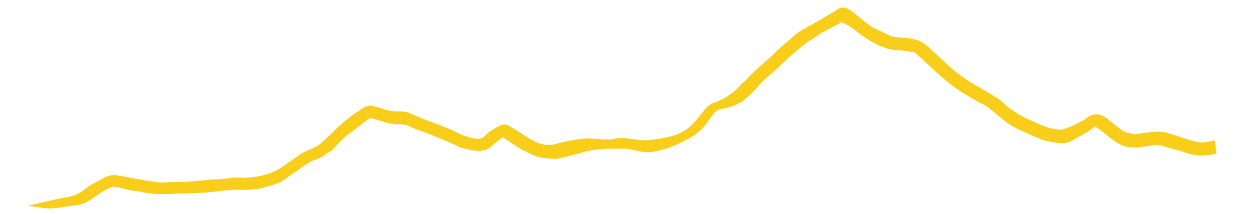

9.1 Masked Patterns on Various Applications

1. Masked Patterns with backgrounds

Patterns with backgrounds are used on print and digital media when layout requires titles and/or text. The choice of patterns should be related to the content. The patterns should be white with a 20% opacity and the outline of the mountain should run from one edge to the other. The color of the background is Marigold.



Full outline

The pattern is 20% opacity.

2. Masked Patterns without backgrounds

Patterns without background are used on print and digital media when there no title or text. The choice of pattern should relate to the content. The pattern should be in Marigold color with 70% opacity and the short outline of the mountain should be used.



Short outline

The pattern is 70% opacity.

The supergraphics should be applied with care on the medium. The sizes are flexible as per the content. The grid must be respected while changing the proportion of the supergraphics.

9.2 Resizing Supergraphics

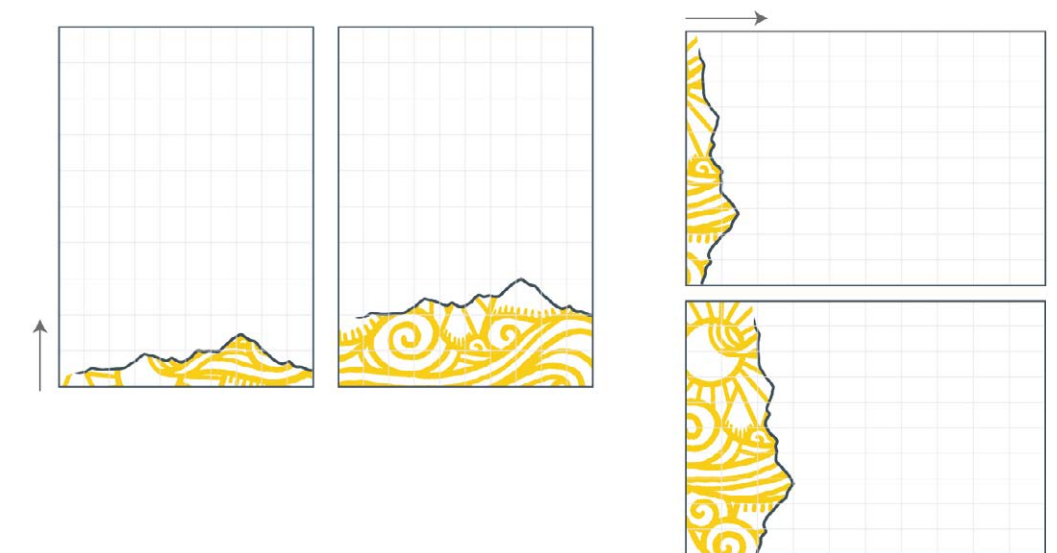
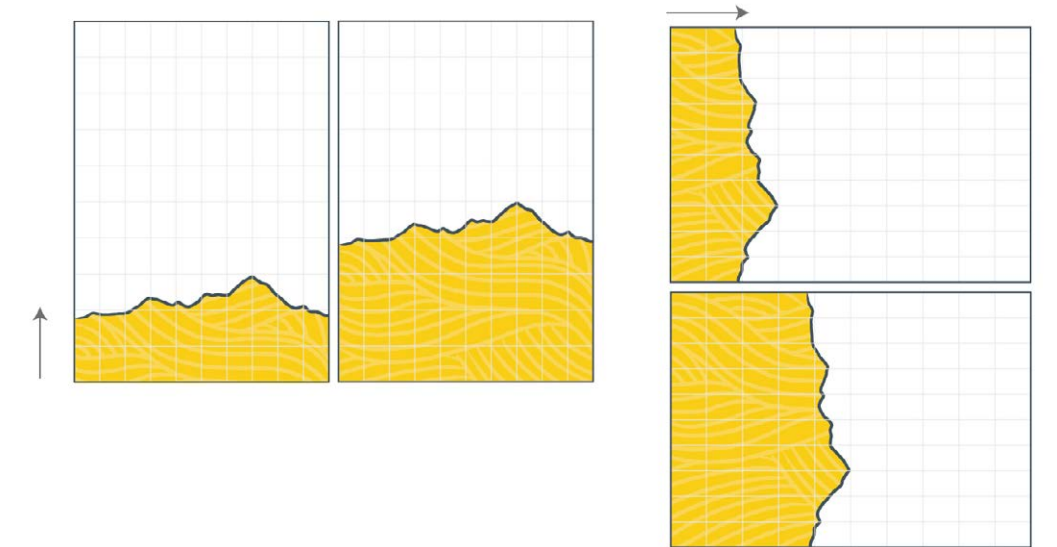

9.3 Masked Pattern with background

The supergraphics should be applied with care on the medium. The sizes are flexible as per the content. The grid must be respected while changing the proportion of the supergraphics.

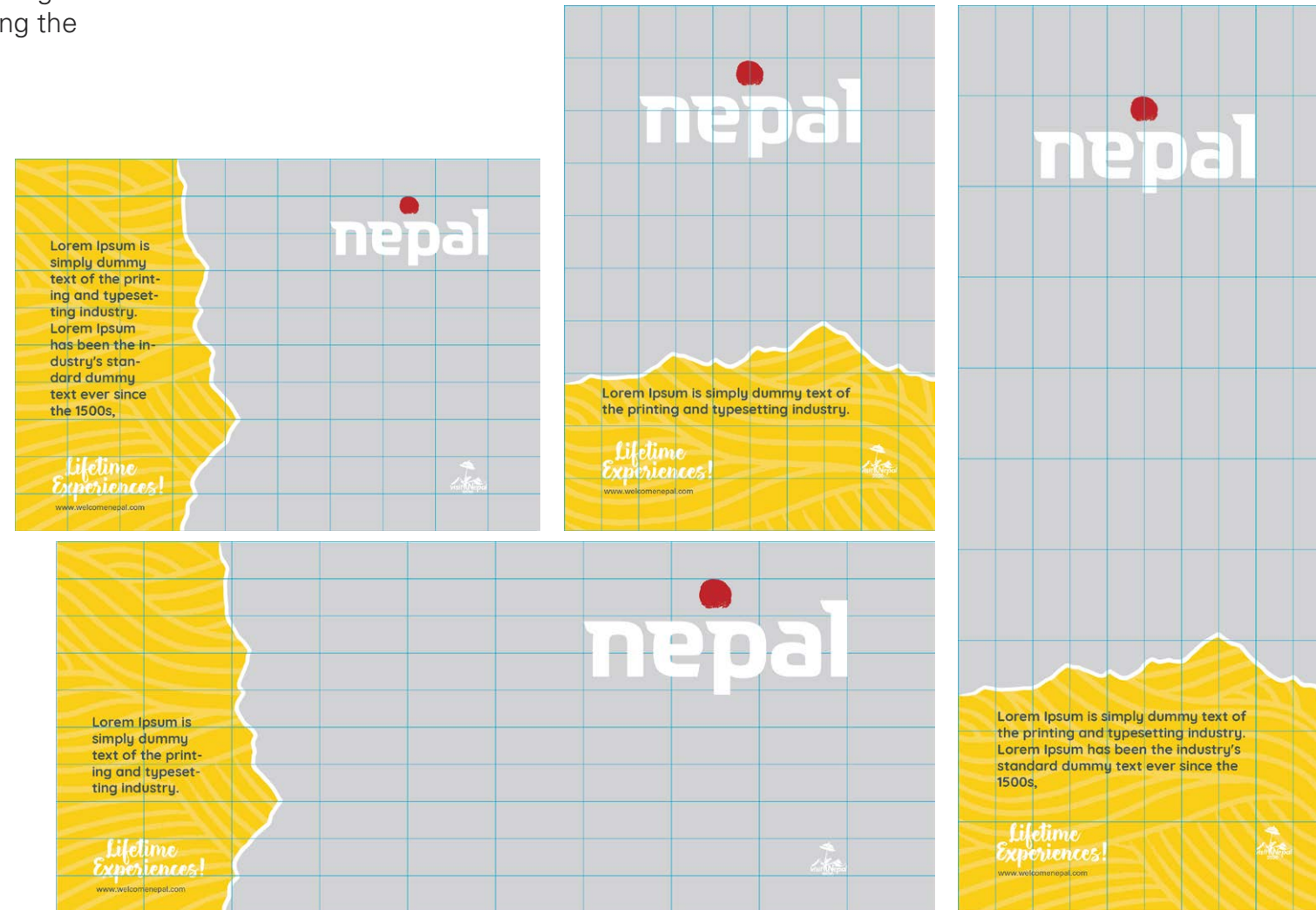

9.4 Masked Pattern without background

The supergraphics should be applied with care on the medium. The sizes are flexible as per the content. The grid must be respected while changing the proportion of the supergraphics.

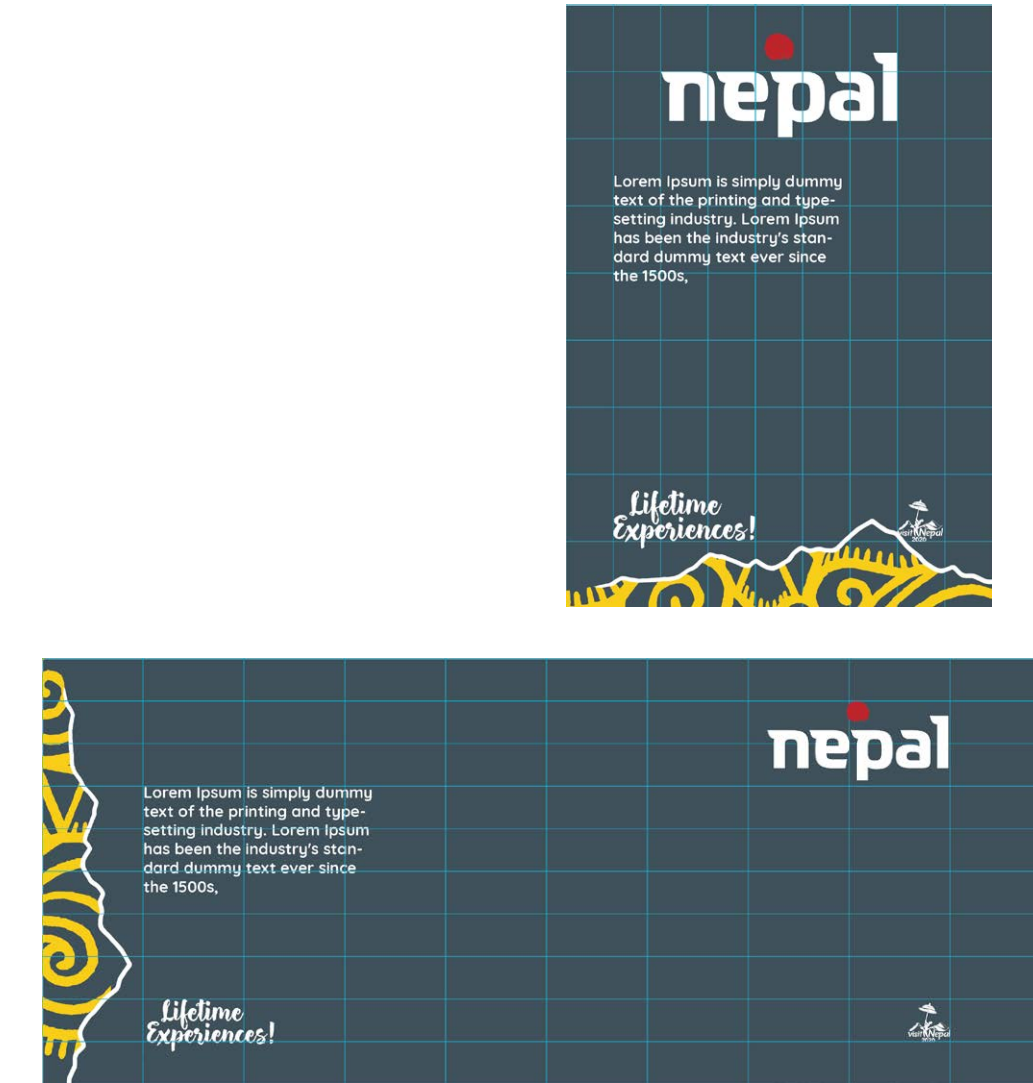

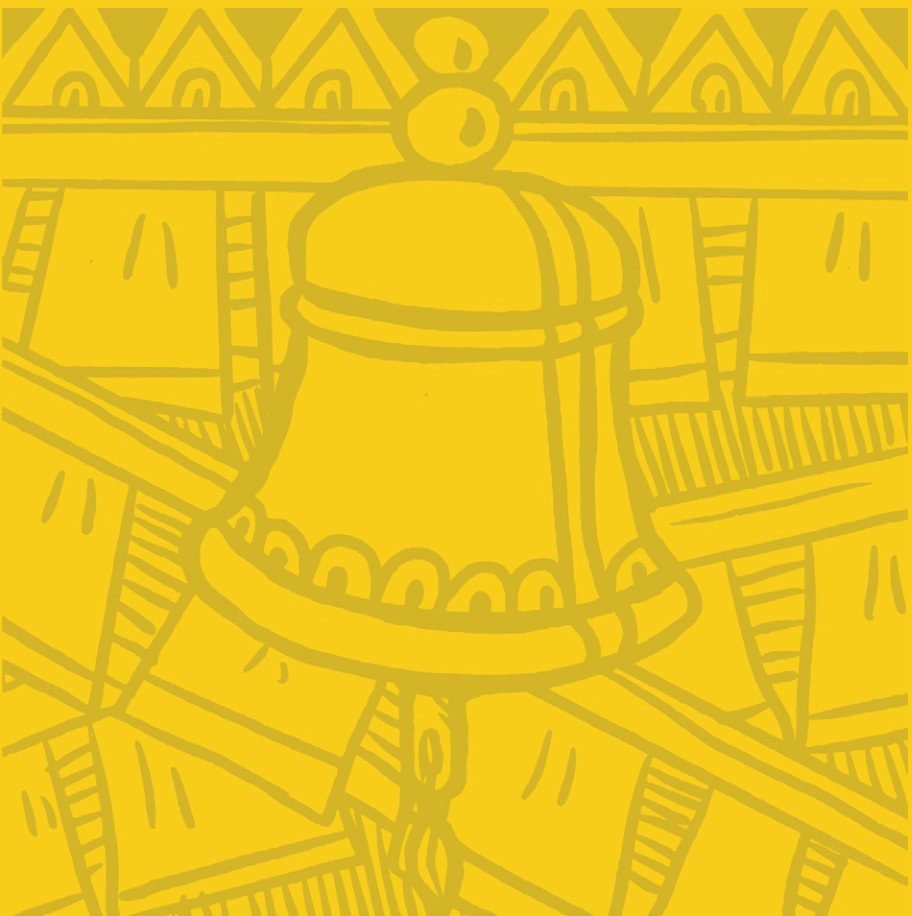

10

Stationery

- 10.1 Visiting Card
- 10.2 Letterhead
- 10.3 Small Envelopes
- 10.4 Large Envelopes
- 10.5 Folder
- 10.6 Compliment Slip

10.1 Visiting Card

The two-sided visiting card should be printed in the given template by a professional offset printer on a thick textured Paper.

SIZE: 5.5cm x 9cm

PAPER

Type Maplitho
Weight 120gsm

Front

NEPAL

Size 3.3cm

FULL NAME

Font Quicksands Medium
Font Size 10pt
Color Bluish Grey

DESIGNATION

Font Quicksands Medium
Font Size 8.5pt
Color Bluish Grey

CONTACT DETAILS

Font Quicksands Medium
Font Size 7.5pt
Color Bluish Grey

Back

VNY LOGO

Size 1.5cm

TAGLINE

Size 5.5

OFFICE DETAILS

Font Quicksands Bold
Font Size 8.5pt
Color Bluish Grey

CONTACT DETAILS

Font Quicksands Medium
Font Size 8.5pt
Color Bluish Grey



10.2 Letterhead

The letterhead is printed in the given template by a professional offset printer in 80gsm A4 Paper.

SIZE: A4

PAPER

Type Maplitho
Weight 120gsm

NEPAL

Size 6cm

VNY LOGO

Size 2cm

TAGLINE

Size 8.5

OFFICE DETAILS

Font Quicksands Bold
Font Size 8.5pt
Color Bluish Grey

CONTACT DETAILS

Font Quicksands Medium
Font Size 8.5pt
Color Bluish Grey



10.3 Small Envelope

The small envelope should be printed in the given template by a professional offset printer.

Envelope Size
22 x 11cm

Paper
Type Maplitho
Weight 120gsm

Nepal Logo
Size 4.5cm

Visit Nepal Logo
Size 2cm

Office Name
Font Quicksands Medium
Font Size 9pt
Color Bluish Grey

CONTACT DETAILS
Font Quicksands Bold
Font Size 9pt
Color Bluish Grey

Tagline
Height 7.5cm



10.4 Large Envelope

The large envelope should be printed in the given template by a professional offset printer.

Envelope Size
22.9 x 32.4 cm

Paper
Type Maplitho
Weight 120gsm

Nepal Logo
Size 7cm

Visit Nepal Logo
Size 2.5cm

Office Name
Font Quicksands Bold
Font Size 10pt
Color Bluish Grey

CONTACT DETAILS
Font Quicksands Medium
Font Size 10pt
Color Bluish Grey

Tagline
Height 8cm



10.5 Folder

The folder should be printed in the given template by a professional offset printer.

Folder Size
23 x 32cm

Paper
Type Maplitho
Weight 300gsm

Nepal Logo
Size 14cm

Tagline
Height 12.5cm

Visit Nepal Logo
Height 3cm

Office Name
Font Quicksands Bold
Font Size 13pt
Color Bluish Grey

CONTACT DETAILS
Font Quicksands Medium
Font Size 13pt
Color Bluish Grey



10.6 Compliment Slip

The compliment slip should be printed in the given template by a professional offset printer.

Slip Size
21 x 9.9cm

Paper
Type Maplitho
Weight 300gsm

Nepal Logo
Size 4.5cm

Visit Nepal Logo
Height 2cm

Office Name
Font Quicksands Bold
Font Size 8.5pt
Color Bluish Grey

CONTACT DETAILS
Font Quicksands Medium
Font Size 8.5pt
Color Bluish Grey

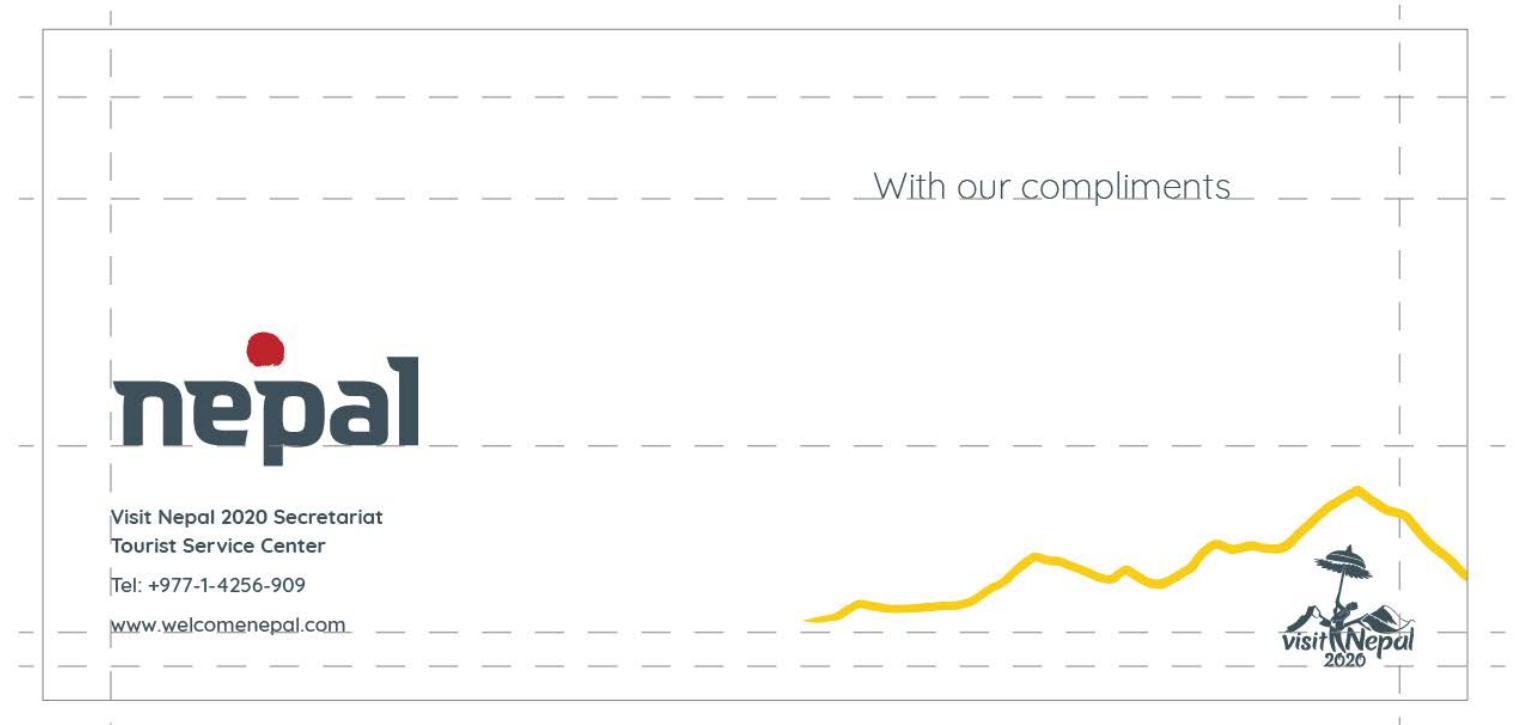



11

Print Media
Applications

- 11.1 Print Media (Vertical)
- 11.2 Print Media (Horizontal)
- 11.3 Print Media (Vertical Extreme)
- 11.4 Print Media (Horizontal Extreme)
- 11.5 Publication Covers
- 11.6 Guide card
- 11.7 Flag
- 11.8 Event Backdrop

11.1 Print Media (Vertical)

Use a 10x10 grid system for vertical print media as shown here.



11.2 Print Media (Horizontal)

Use a 10x10 grid system for horizontal print media as shown here.



11.3 Print Media (Extreme Vertical)

Use a 10x10 grid system for extreme vertical print media as shown here.



54



55



11.4 Print Media (Extreme Horizontal)

Use a 10x10 grid system for extreme horizontal print media as shown here.

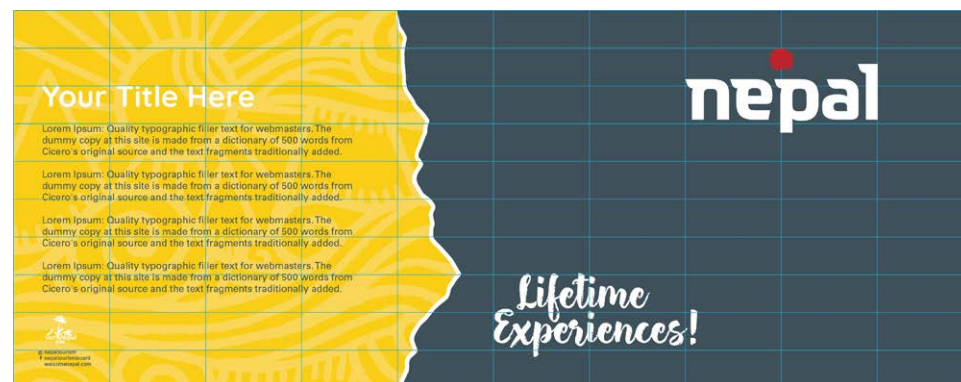
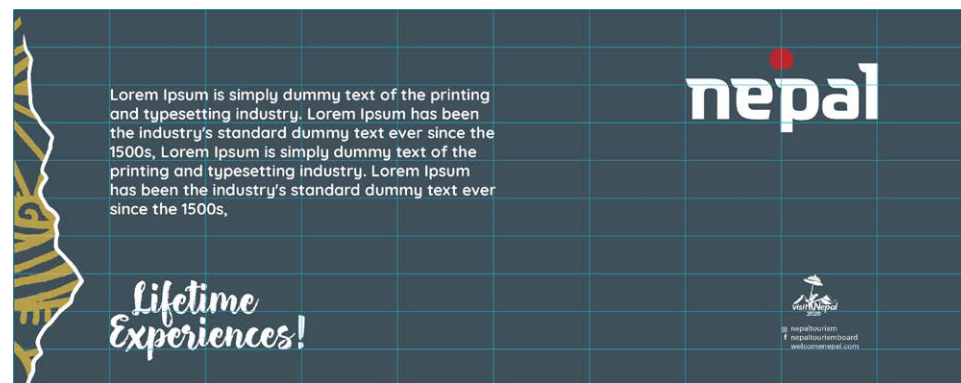

11.5 Publication

The publication should be printed in the given template by a professional printer.



The guide card should be printed in the given template by a professional offset printer.

Guide Size
7 x 10.3cm

Paper
Type Maplitho
Weight 300gsm

11.6 Guide card



11.7 Flag

The flag should be printed in the given template by a professional printer.

Fabric : Polyester-nylon blend



11.8 Event Backdrop

The event backdrop should be printed in the given template by a professional digital printer.

Material : High quality non-textured flex or silk medium, mounted on wooden board.

The front carpet is grey and spotlights are warm.

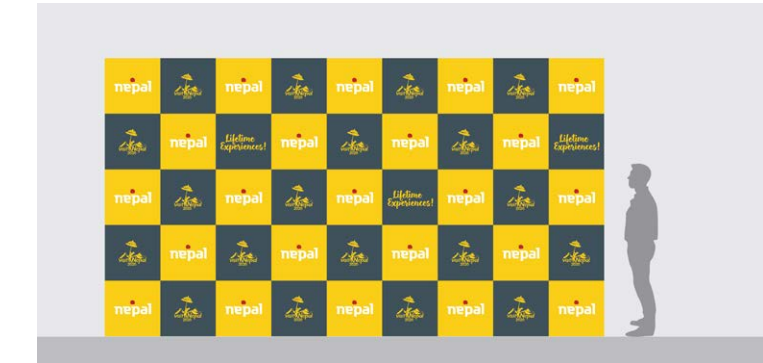



12

Packaging

- 12.1 Product Tag
- 12.2 Cloth Label
- 12.3 Box
- 12.4 Shopping Bag

12.1 Product Tag

The tag should be printed in the given template by a professional screen printer on handmade paper.

Size: 6cm x 8cm

Main Graphics

Size 5cm

Information

Font Univers LT Std 55 Roman

Font Size 7.8pt

Color Marigold



The label should ideally be woven.

Size: 5cm x 2cm

12.2 Cloth Label

Unfolded



Folded



Unfolded



Folded



Dimensions

Unfolded



Folded



12.3 Boxes

The boxes should be made by a professional printer using high quality matt or handmade paper.



12.4 Bags

The bags should be made by a professional printer using high quality matt or handmade paper.





13

Exhibitions

- 13.1 Exhibition Booth
- 13.2 Merchandising Kiosk

13.1 Exhibition Booth

The Nepal pavilion at international fairs should be constructed in the given style in consultation with a professional design house. The booth should be as open as possible, well arranged and easily accessible for persons with disabilities. All booths should be built on the same model/design. However, dimensions may differ.

The Nepal brand should be visible from all sides of the pavilion and at several levels (high and low).

The pavilion should carry the following:

1. Communication collaterals (flyers, leaflets etc)
2. Photography
3. Films and videos
4. Gift items
5. Merchandising samples
6. Cushions in Nepali fabrics
7. All the elements of the branding

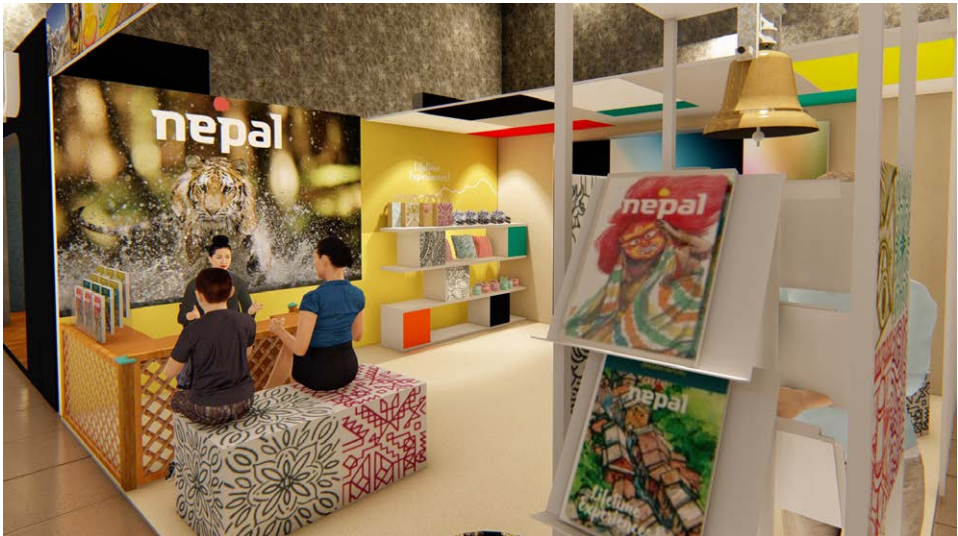

13.2 Merchandising Kiosk

The kiosk should be constructed in the given style in consultation with a professional design house. The booth should be as open as possible, well arranged and easily accessible for persons with disabilities. All kiosks around the country and abroad should be built on the same model/design. However, dimensions may differ. Visual merchandising of VNY 2020 should be recognizable.

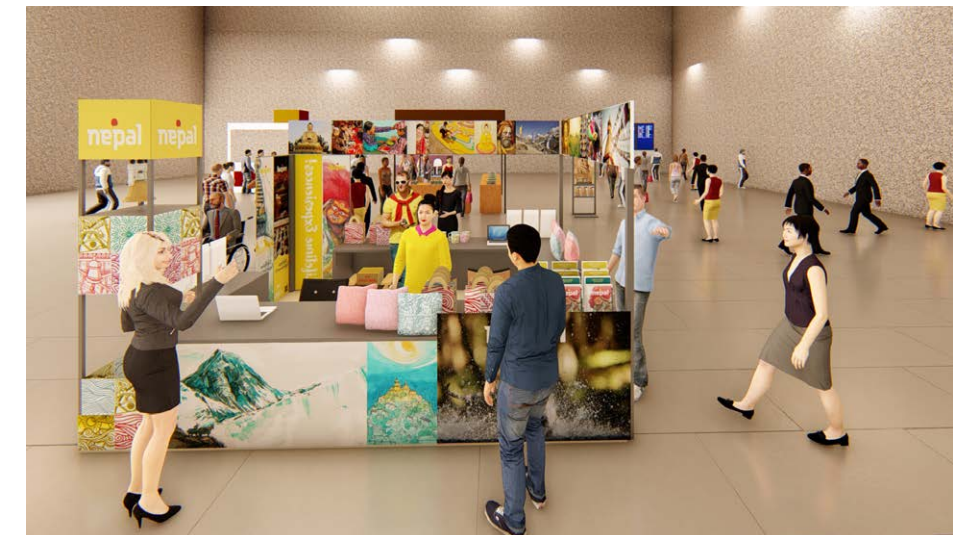



Environmental Design 14

- 14.1 Wayfinding Signage
- 14.2 Place Signage
- 14.3 Signage at Places of Interest
- 14.4 Map Case

14.1 Wayfinding Signage

Height of pole: 3m

Size of each arrow 80 x 16cm

Material
Wrought iron

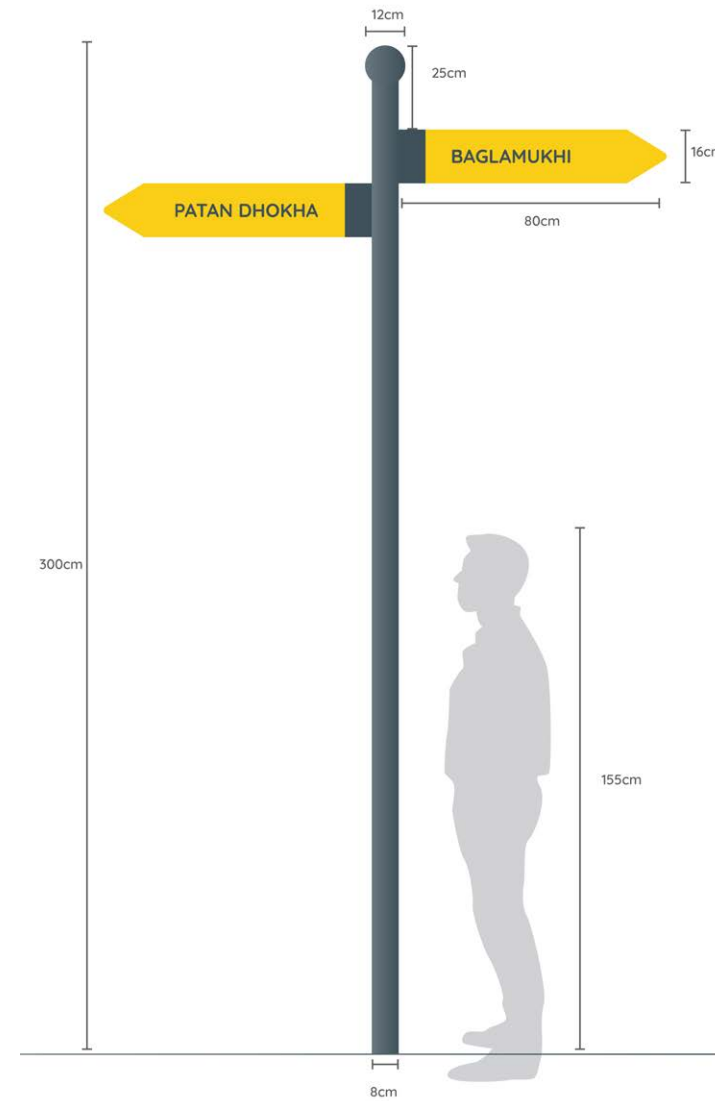

76

Use a 10x10 grid system for place signage as shown here.

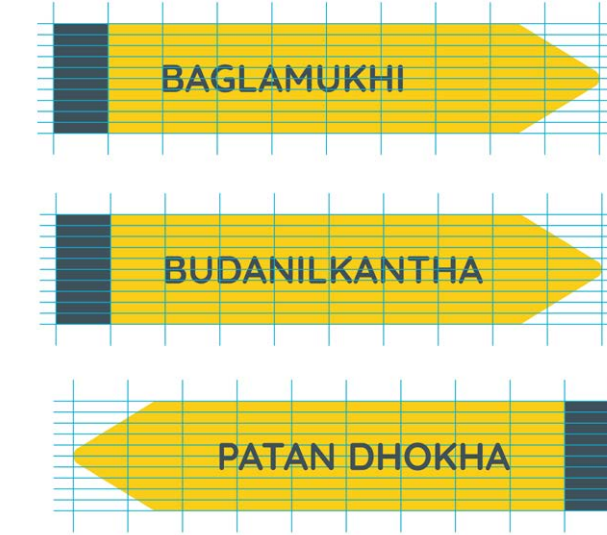

Signage preview in 3D wire-frame structure.



77

14.2 Place Signage

Material: Metal or brass
High quality durable non-toxic spray paint.

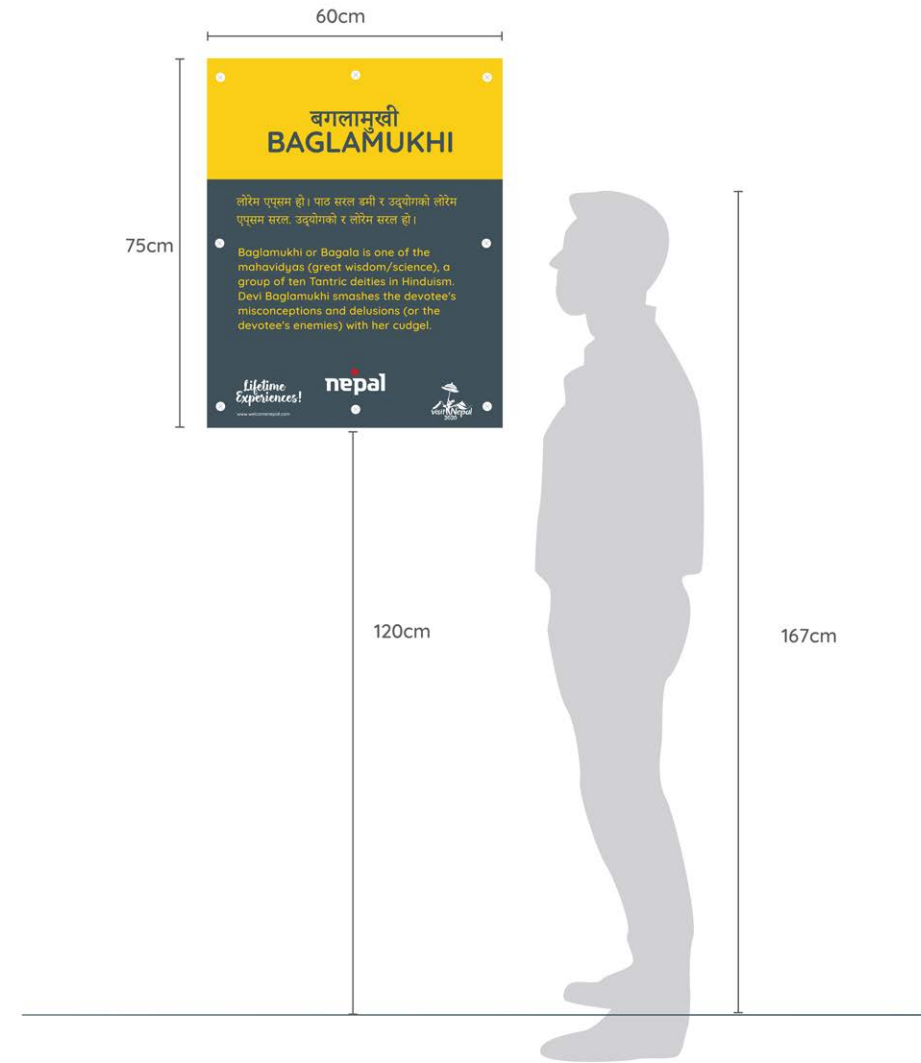

Use a 10x10 grid system for place signage as shown here.

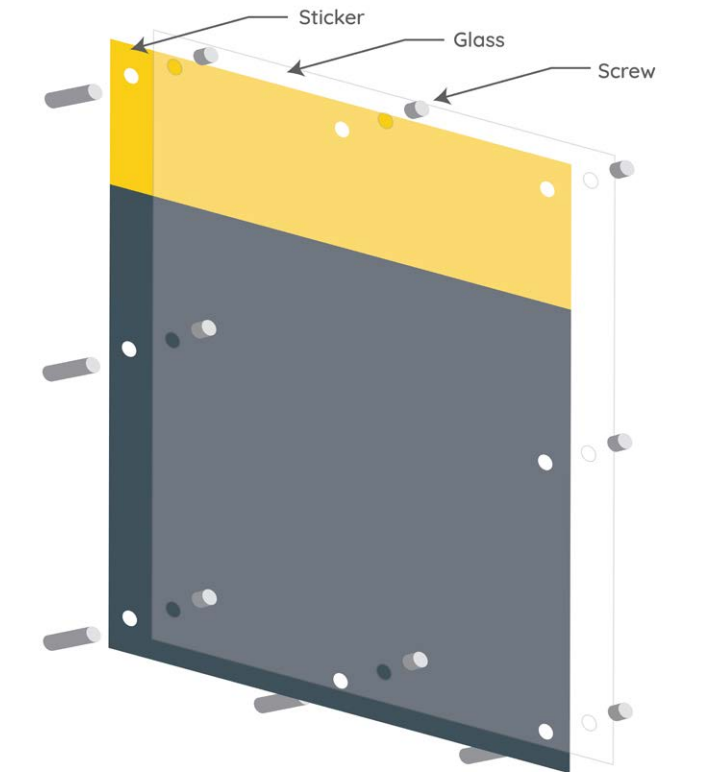

Signage preview in 3D wire-frame structure.

14.3 Signage at Places of Interest

Material: Metal or brass
High quality durable non toxic spray paint.

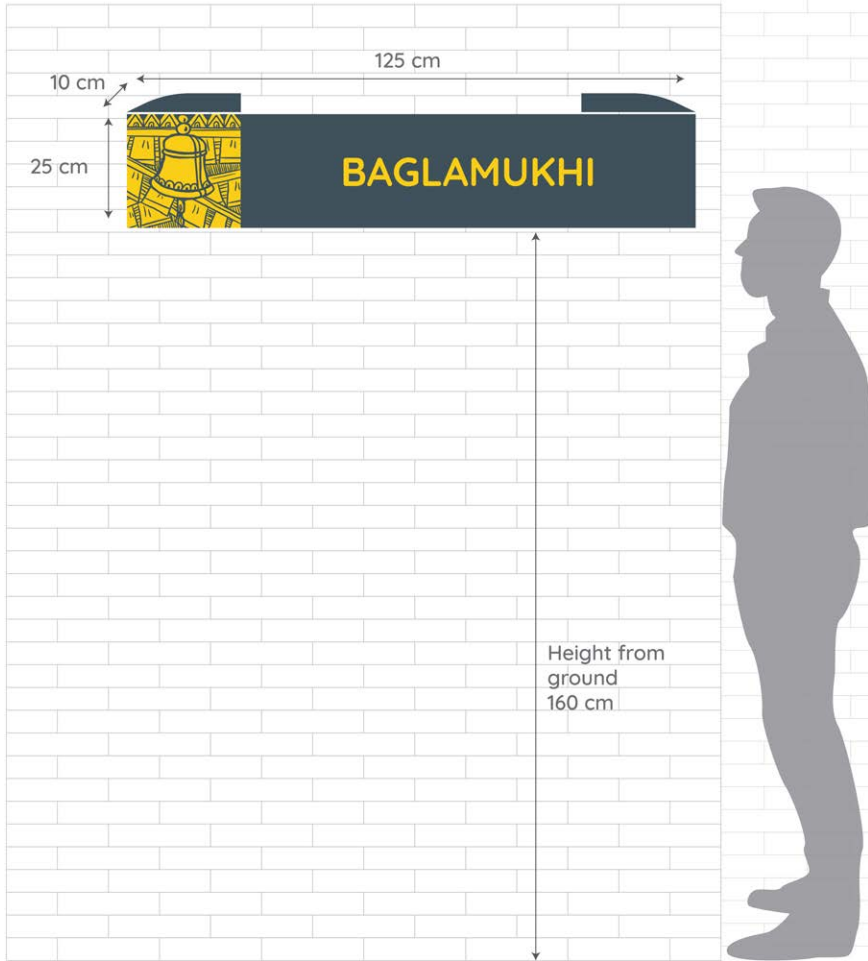
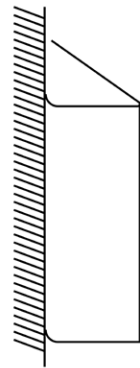

14.4 Map Case

Double sided free standing light box structure.





15

Online Applications

- 15.1 Website Template
- 15.2 Power-point Template

15.1 Website

The website should be professionally designed and responsive.

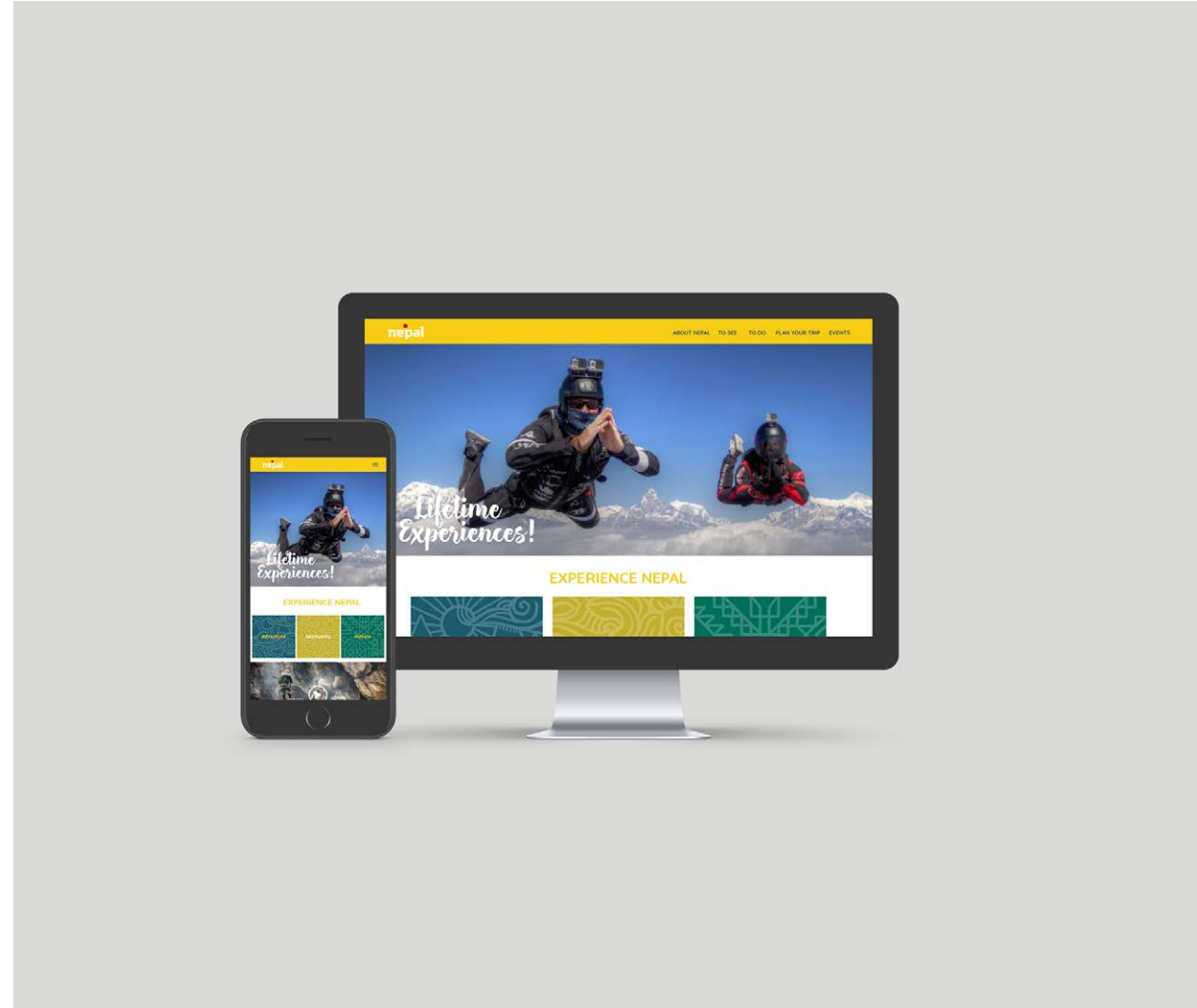

The landing page picture should be spectacular and changed regularly.

The three areas of focus of VNY 2020 are Adventure, Spirituality and Culture. They are presented under their respected colors.

- 
Adventure
 Turquoise - Hex #1A5B6D
- 
Spirituality
 Gold Hex #C4B130
- 
Culture
 Teal Green Hex #00705C

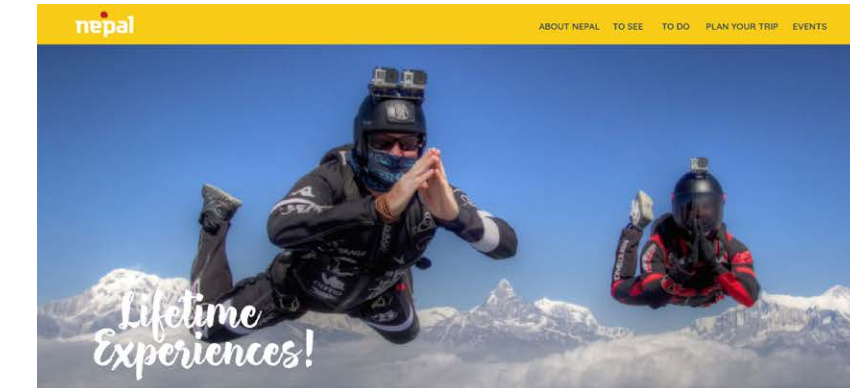

EXPERIENCE NEPAL

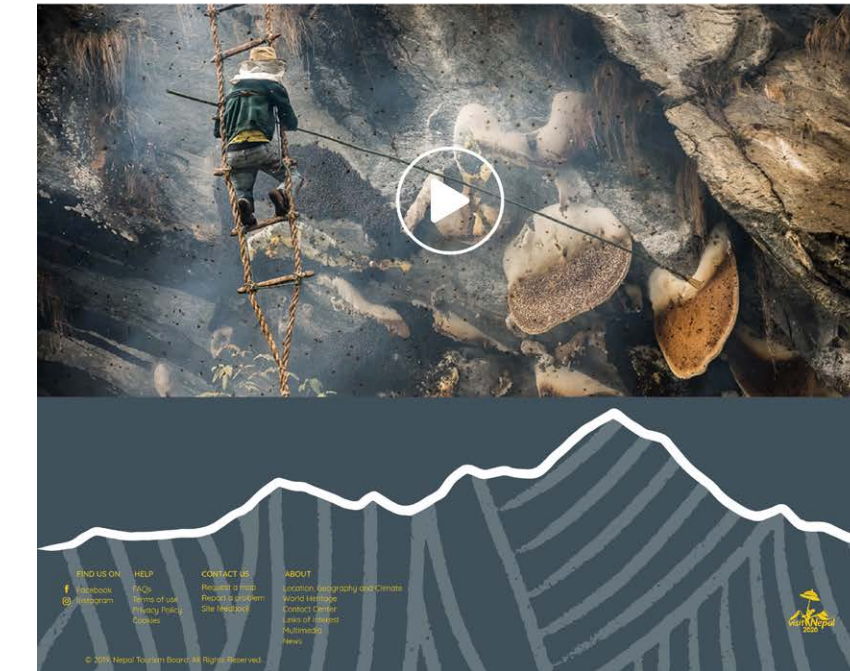

15.2 Power-point Template

This is a template for VNY 2020 Powerpoint Presentations.

The title slide features the Nepal logo centered and tagline at the bottom left corner.

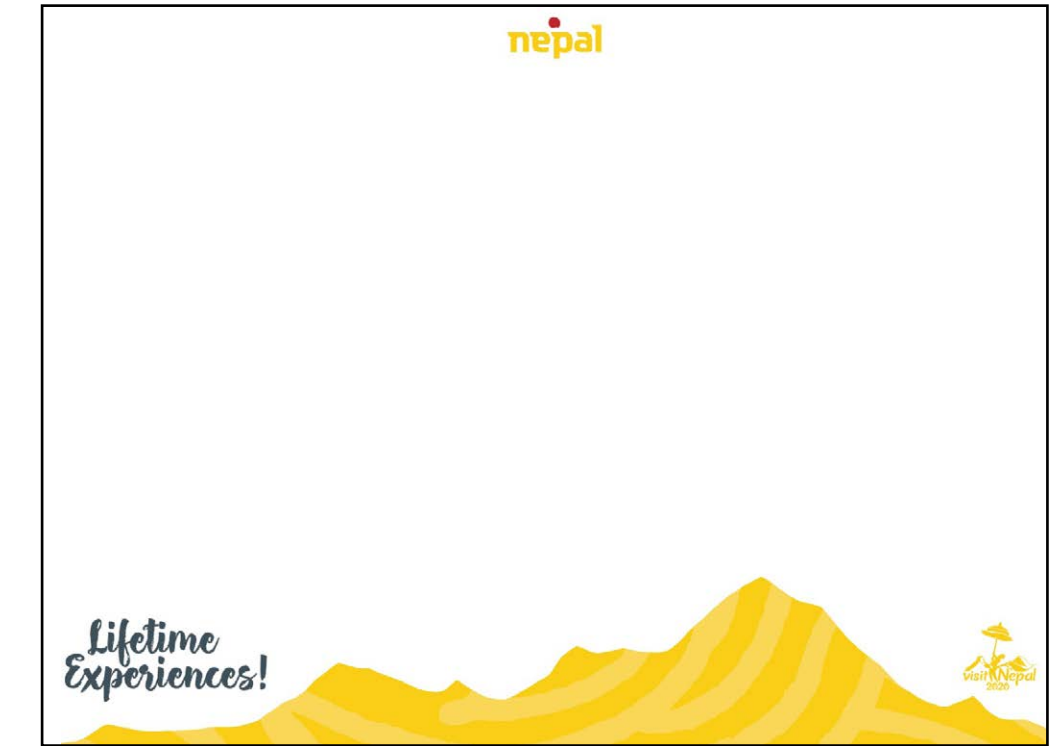



16

Social Media

- 16.1 Facebook
- 16.2 Instagram

16.1 Facebook



Profile Picture
Nepal is centered



Banner
Logo and Tagline in white
Use any of the patterns in white 20% opacity over yellow background. Refer to section on patterns.



Post
Tagline in white
Describe the image and credit the photographer in the caption.

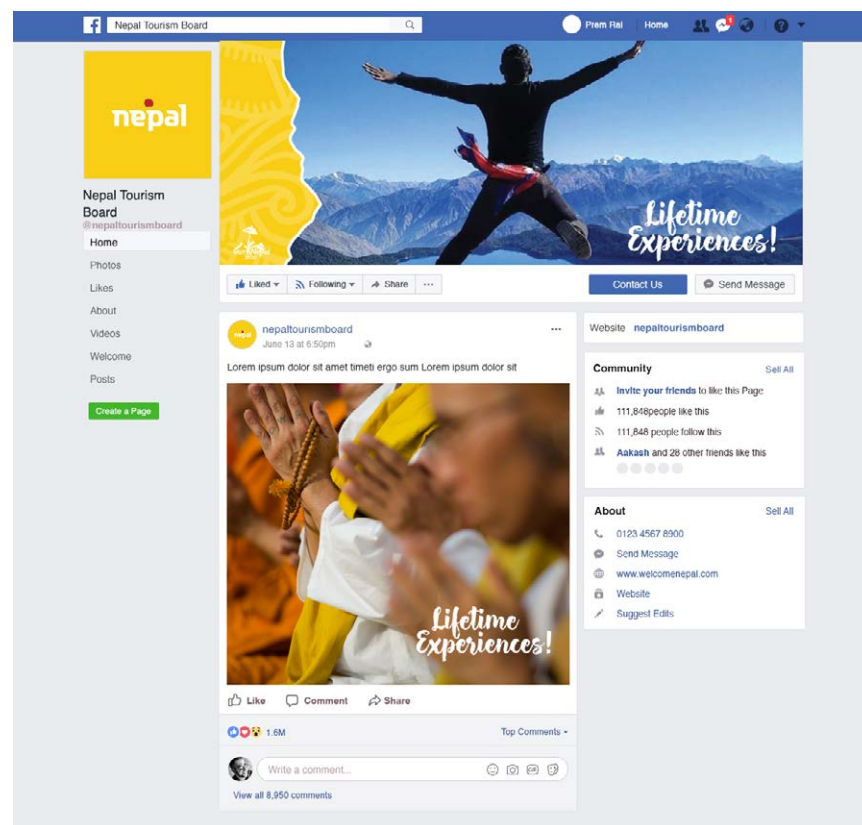

16.1 Instagram



Profile Picture
Nepal is centered



Post
Tagline in white
Describe the image and credit the photographer in the caption.



Aesthetic Tiling of Instagram posts.
Tagline in white
Describe the image and credit the photographer.

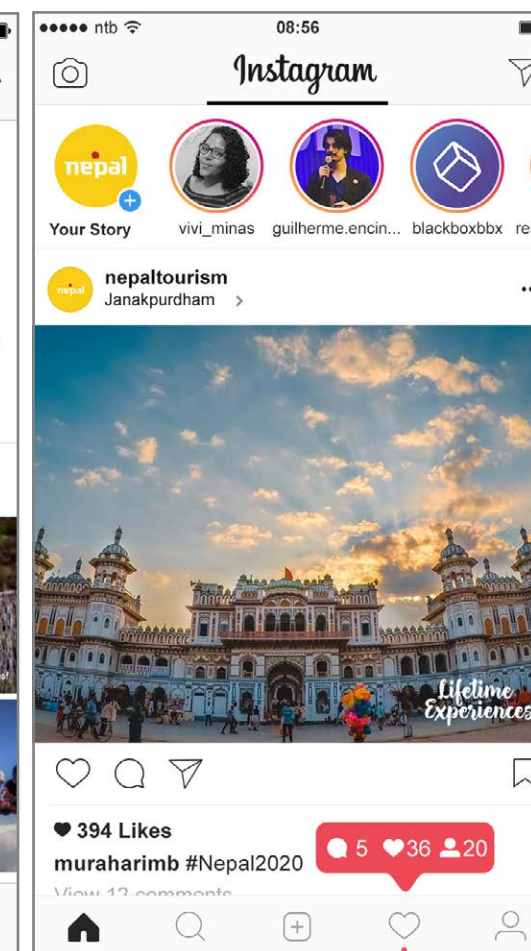
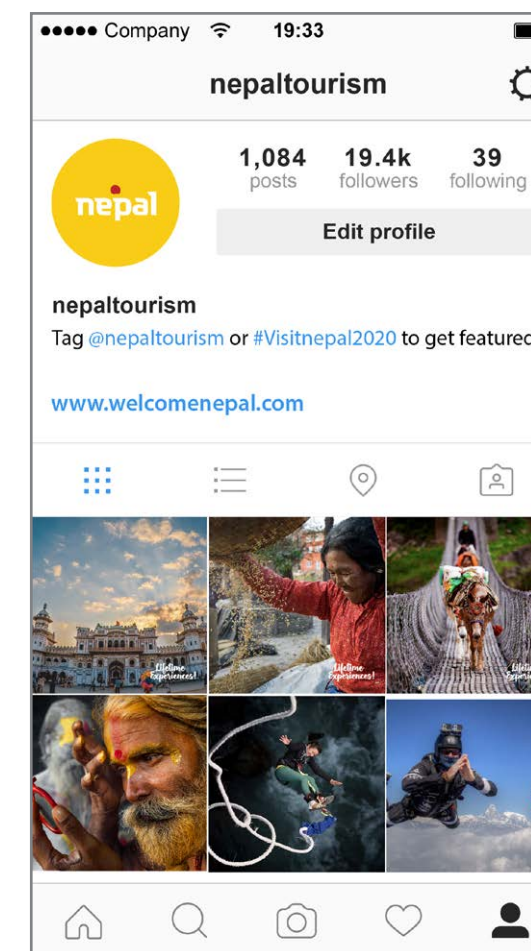



17

Transport

- 17.1 Tourist Bus
- 17.2 Cars
- 17.3 Airline

17.1 Tourist Bus

Leave as much clear space as possible around the name Nepal so it is clearly seen from and on moving vehicles.



17.2 Cars



17.3 Airline

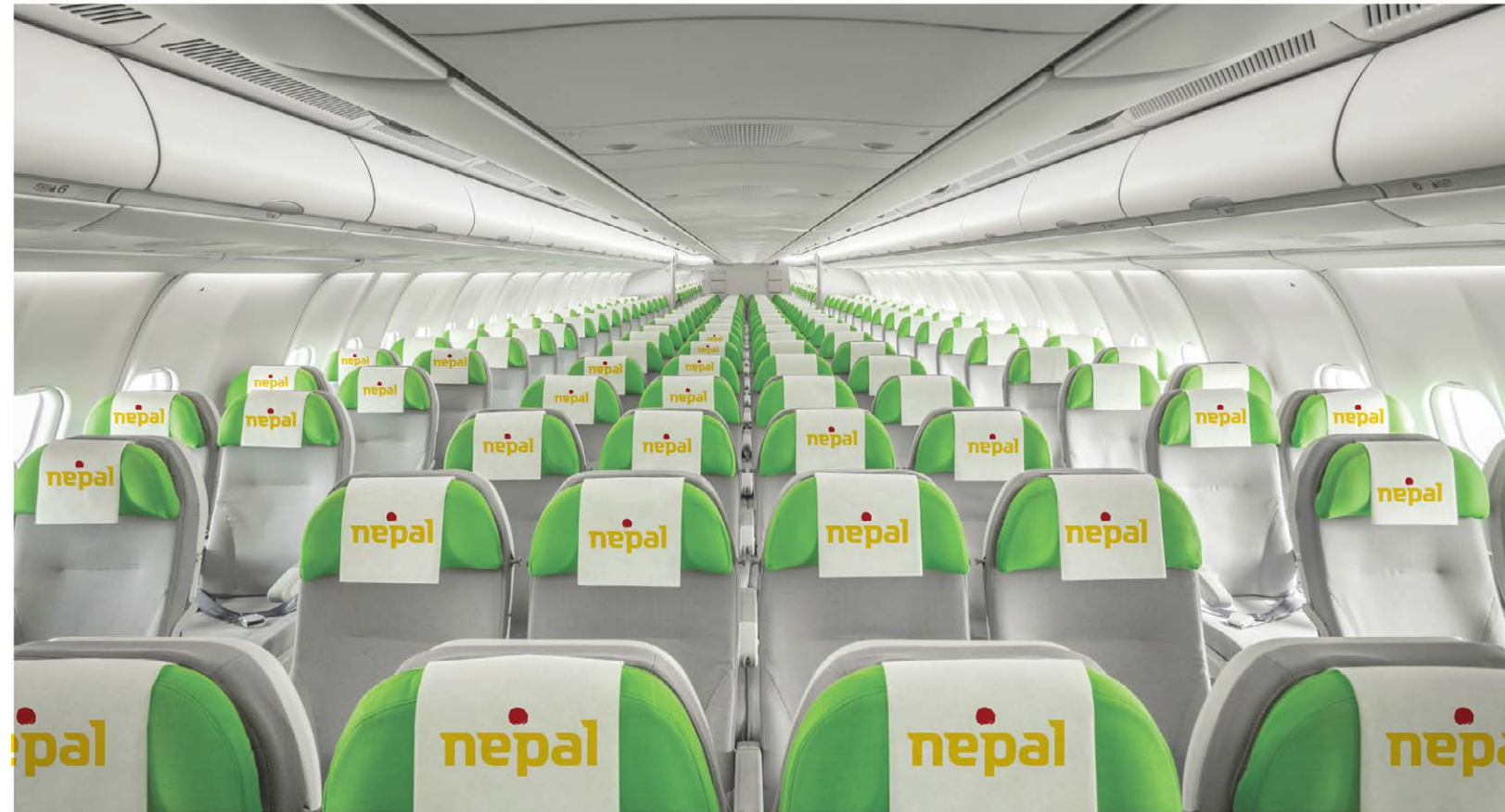

This section is only for inspiration as at the time of producing this book, we did not have enough technical information about branding the airline industry.



18

Uniforms

- 18.1 Women's Blouse 1
- 18.2 Women's Blouse 2
- 18.3 Men's Shirt 1
- 18.4 Men's Shirt 2
- 18.5 Straight Leg Jeans
- 18.6 T-shirt
- 18.7 Shoes
- 18.8 The Look

18.1 Women's Blouse 1

FABRICS

Bluish Grey: Polyester Georgette

Yellow: Polyester/Cotton Percalé

Seam Finish: Serged closed except at side seams

Side seam Finish: 1/4 inch serged then folded twice and stitched

Hem Finish: 1/4 inch serged then folded twice and stitched

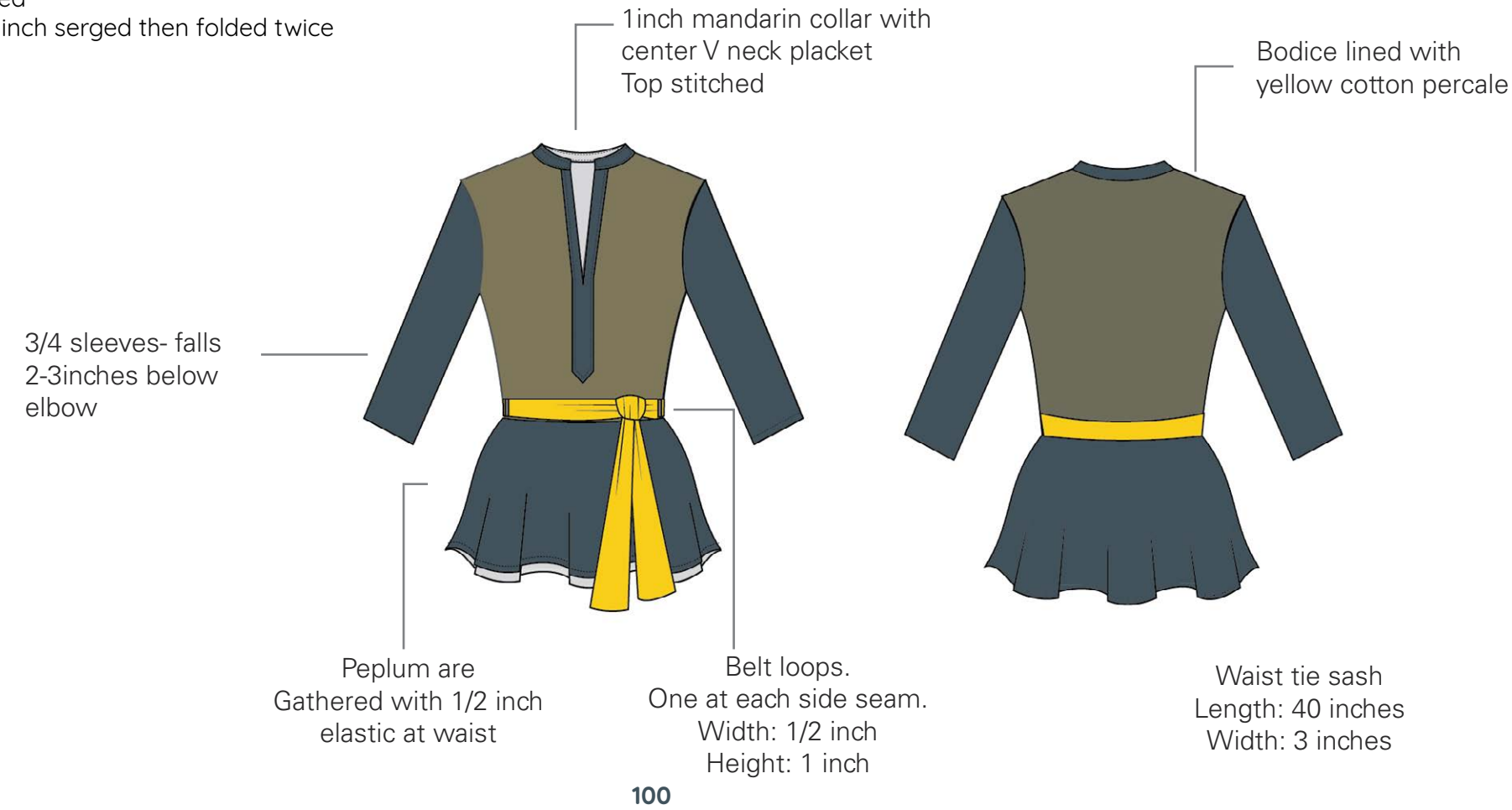

18.2 Women's Blouse 2

FABRICS

Bluish Grey: Polyester Georgette

Yellow: Polyester/Cotton Percalé

Seam Finish: Serged closed except at side seams

Side seam Finish: 1/4 inch serged then folded twice and stitched

Hem Finish: 1/4 inch serged then folded twice and stitched

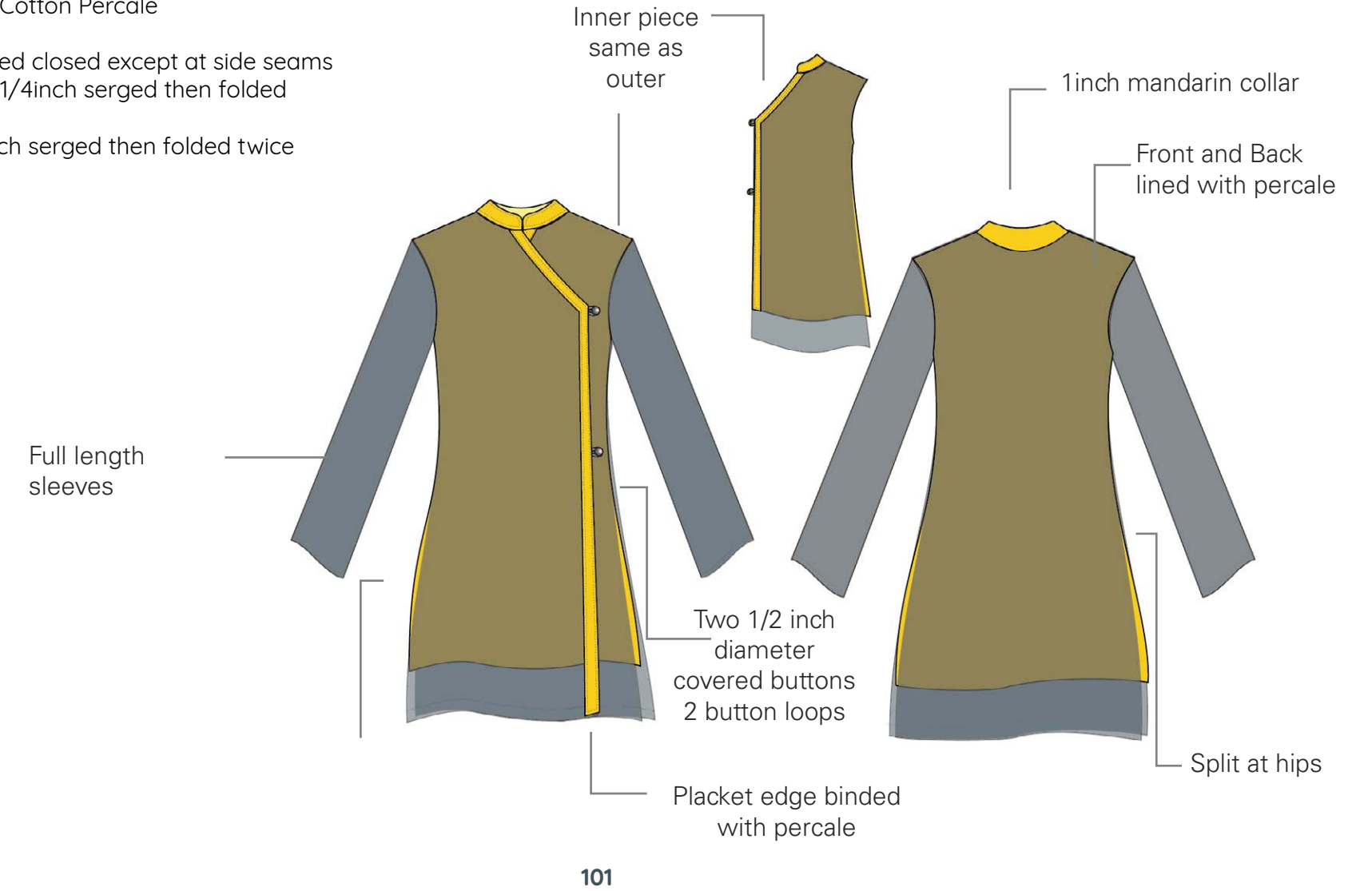

18.3 Men's Shirt 1

FABRICS

Bluish Grey: Polyester Georgette
Yellow: Polyester/Cotton Percale

Seam Finish: Serged closed except at side seams
Side seam Finish: 1/4 inch serged then folded twice and stitched
Hem Finish: 1/4 inch serged then folded twice and stitched

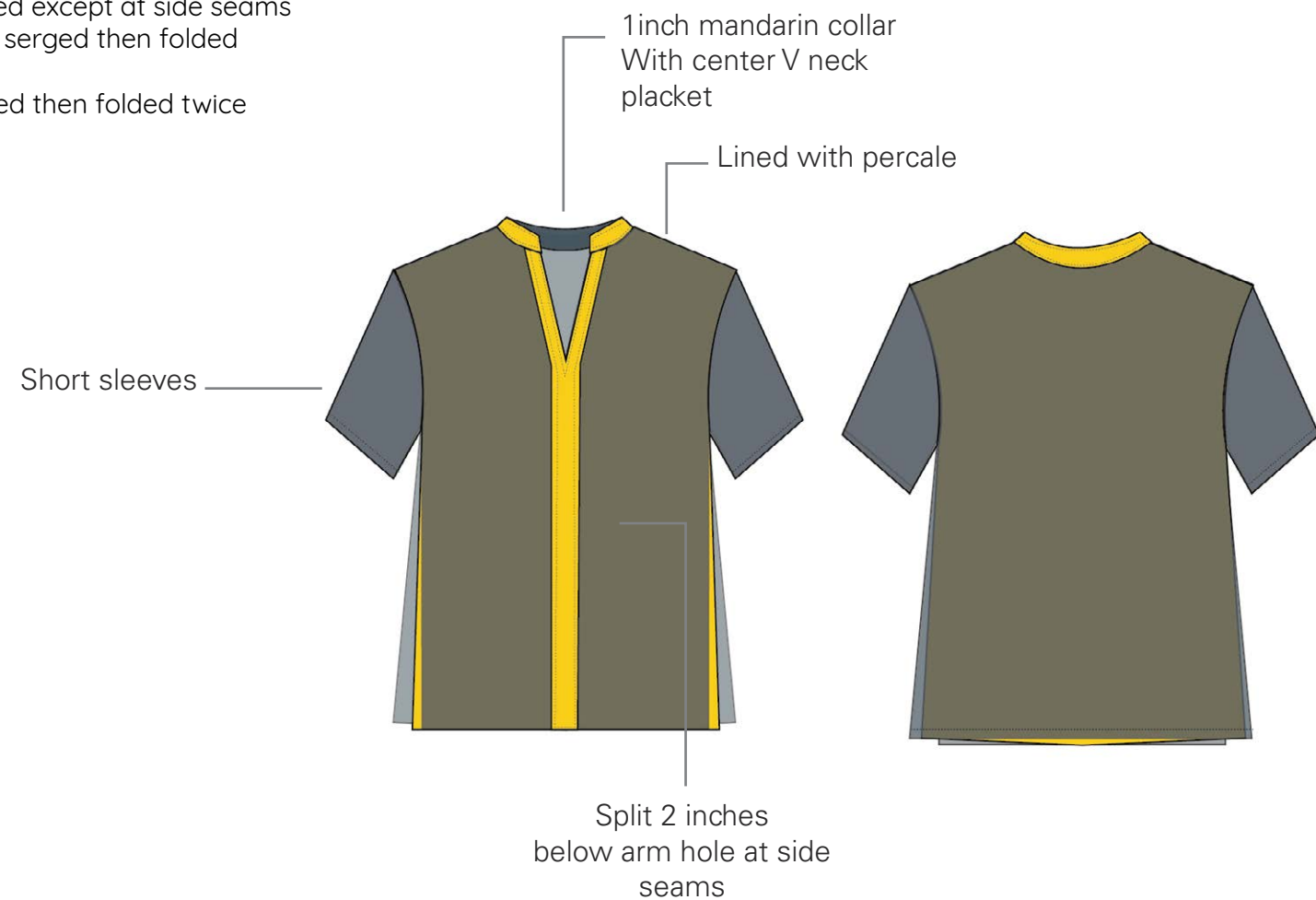

102

18.4 Men's Shirt 2

FABRICS

Bluish Grey: Polyester Georgette
Yellow: Polyester/Cotton Percale

Seam Finish: Serged closed except at side seams
Side seam Finish: 1/4 inch serged then folded twice and stitched
Hem Finish: 1/4 inch serged then folded twice and stitched

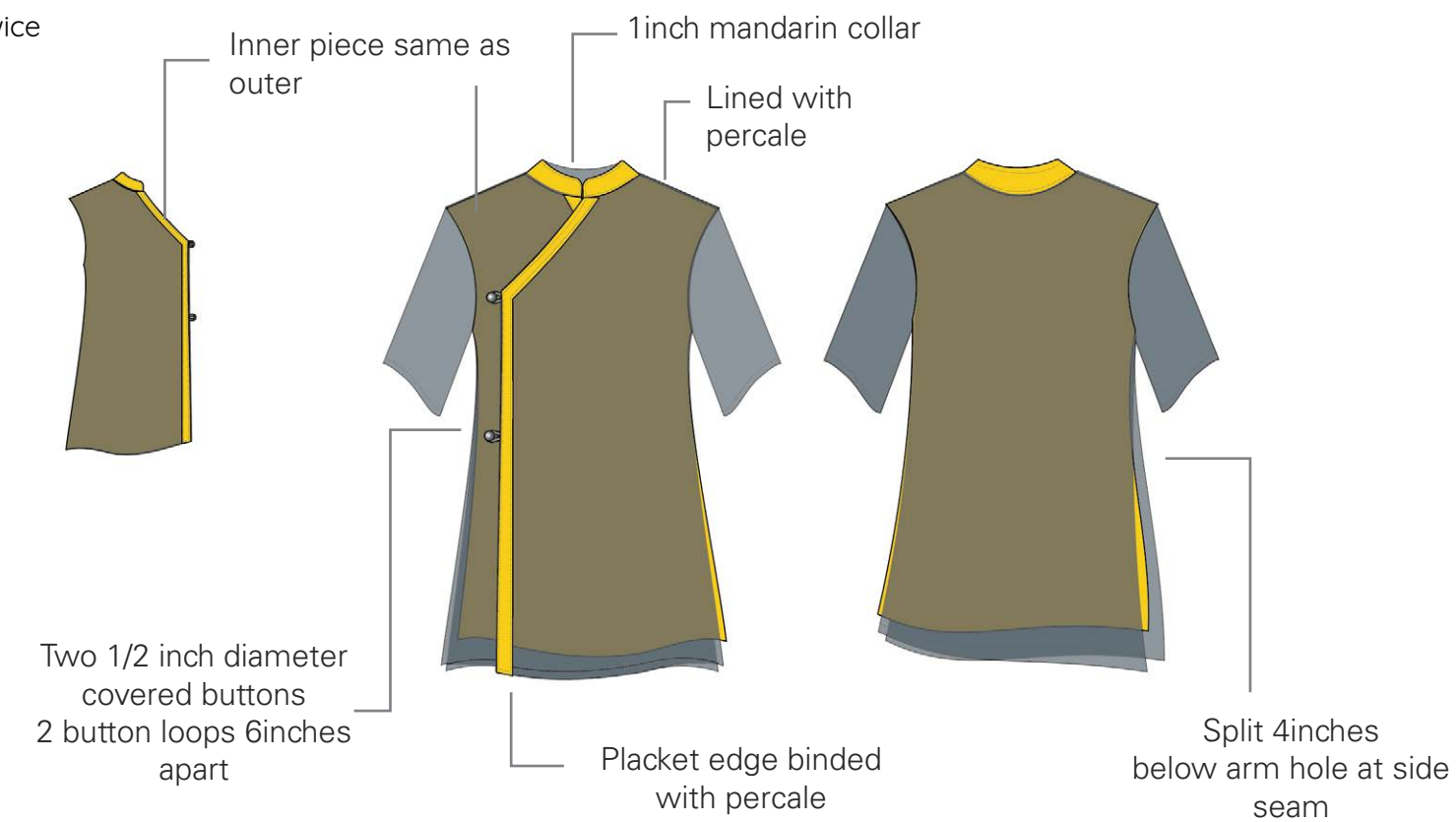

103

18.5 Straight Leg Jeans

FABRICS
Bluish Grey: Cotton Denim
Seam Finish: Serged closed
Hem Finish: Folded twice and stitched

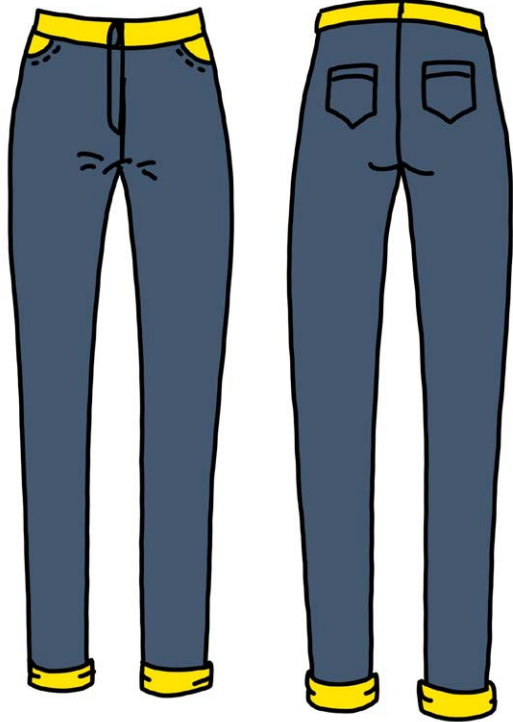

18.6 T Shirt

Lifetime Experiences!

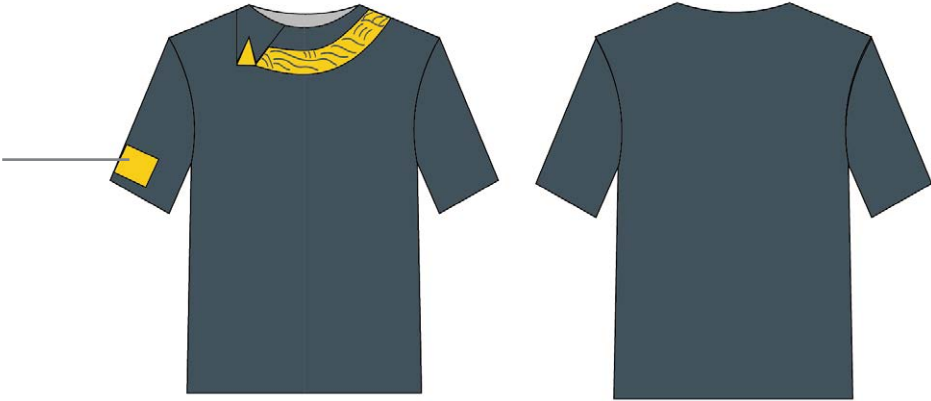

Front



Back

18.7 Shoes

Hightop yellow sneakers with white or grey laces.



18.8 The Look



For further information please contact:
Visit Nepal Year 2020 Secretariat
Kaiser Mahal, Kantipath
Kathmandu, Nepal

Or Image Ark

This version of the brand guidelines is the first issued for the Nepal Year 2020 identity as of June 2019. It applies only to the Nepal Year 2020 identity as it appears in this book and does not concern any other version that may have been issued for the previous identity of Visit Nepal Year 2020.

Please ensure all uses of the Nepal Year 2020 brand complies with any applicable regulations and have been approved by a Nepal Year 2020 representative.

This guide book is created and maintained by

IMAGEARK

www.image-ark.com

These concepts and designs are the property of Visit Nepal Year 2020 Secretariat who claims the intellectual property thereof. These designs are to be used solely for the purpose of promoting Nepal in the context of the Visit Nepal 2020 campaign. Any improper or unauthorized use of any portion of this visual identity will be liable to legal proceedings according to applicable copyright laws.

Lifetime Experiences!

